

CONTENTS

| | |
|---|-----------|
| Contents | 2 |
| Compliance | 4 |
| Underwriters Laboratories (UL) | 4 |
| FCC | 4 |
| Installation | 4 |
| Introduction | 5 |
| Technical Support | 5 |
| Return Material Authorization (RMA) | 5 |
| Warranty Service | 6 |
| Advanced Replacements | 6 |
| Overview | 7 |
| Installation | 8 |
| Before You Begin | 9 |
| Setting the Address | 10 |
| Placement | 11 |
| Wiring | 13 |
| No SLC Devices | 13 |
| Class A SLC Loops | 14 |
| Class B SLC Loops | 15 |
| Class X SLC Loops | 16 |
| Testing | 17 |
| Specifications | 18 |
| Index | 19 |

Glossary **20**

COMPLIANCE

Underwriters Laboratories (UL)

Fire Alarm Subassembly
Kentec Electronics Ltd

FCC

This equipment has been tested and found to comply with the limits for a Class A digital device, pursuant to Part 15 of the FCC Rules. These limits are designed to provide reasonable protection against harmful interference when the equipment is operated in a commercial environment. This equipment generates, uses, and can radiate radio frequency energy and, if not installed and used in accordance with the Installation Manual, may cause harmful interference to radio communications. Operation of this equipment in a residential area is likely to cause harmful interference in which case the user will be required to correct the interference at his own expense. Any changes or modifications not expressly approved by Kentec Electronics Ltd could void the user's authority to operate this equipment under the rules and regulations of the FCC.

Operation is subject to the following two conditions:

- (1) This device may not cause harmful interference, and
- (2) This device must accept any interference received, including interference that may cause undesired operation.

Installation

Install this product in accordance with NFPA 13, NFPA 72, NFPA 70, and NEC 70 and all local codes.

All field wiring should be installed using fire rated cables according to the NFPA 72. Riser conductors shall be installed in accordance with the survivability from attack by fire requirements in National Fire Alarm Code, NFPA 72, Section 12.3. Riser conductors shall employ either a 2 hour rated cable system, or meet requirements approved by the AHJ.

INTRODUCTION

Technical Support

For technical support, contact Kentec Electronics, Ltd at +44 (0)1322 222121 or techsupport@kentec.co.uk.

Prior to contacting technical support, have the following information available:

- Product part number
- Purchase order or order number
- Product serial number
- Current function of the product
- Expected function of the product
- Installation of the product

Return Material Authorization (RMA)

Contact Technical Support to obtain an RMA for any product to be returned. Returns will not be accepted without an accompanying RMA number. An RMA number is assigned when:

- Tech Support acknowledges a possible product failure.
- A product was damaged during shipping
- An incorrect product was shipped
- An order was placed using an incorrect part number *
- An order was placed using an incorrect part quantity *
- An order is no longer required *

* Restocking fees may apply.

All returned products are tested to confirm operating failures experienced in the field. If the product is found to be functional, contractors must absorb expenses for return shipping, as well as the cost and shipping of the advanced replacement product.

Prominently display the RMA number on all packages sent for return. Ship all return products to:

Attention: RMA # _____
Kentec Electronics, Ltd
Units 25-27 Fawkes Avenue

Questor, Dartford
Kent. DA1 1JQ
United Kingdom

Warranty Service

Technical Support can replace or repair a defective product when the original purchase is within the warranty period defined in the sales contract. Check your contract for more information, or contact your sales representative about your specific warranty period.

Advanced Replacements

Products that fail to operate in the field can be replaced quickly using the advanced replacement process. The advanced replacement process is available to all contractors who maintain an acceptable line of credit.

Initiate the advanced replacement process by requesting an RMA number from a Tech Support representative. Advanced replacements can be shipped to your location when the product is covered under warranty and when a replacement product is in stock.

- Advanced replacements can be expedited at the request of the contractor. Shipping costs associated with this process are the responsibility of the contractor.
- Products returned using the advanced replacement process must be received within 30 days of the RMA issue date.

OVERVIEW

The Dual Loop Panel Module provides two supervised loop functions for the fire alarm control panel. All models of the Taktis Fire Alarm Control Panel contain at least one Dual Loop Panel Module.

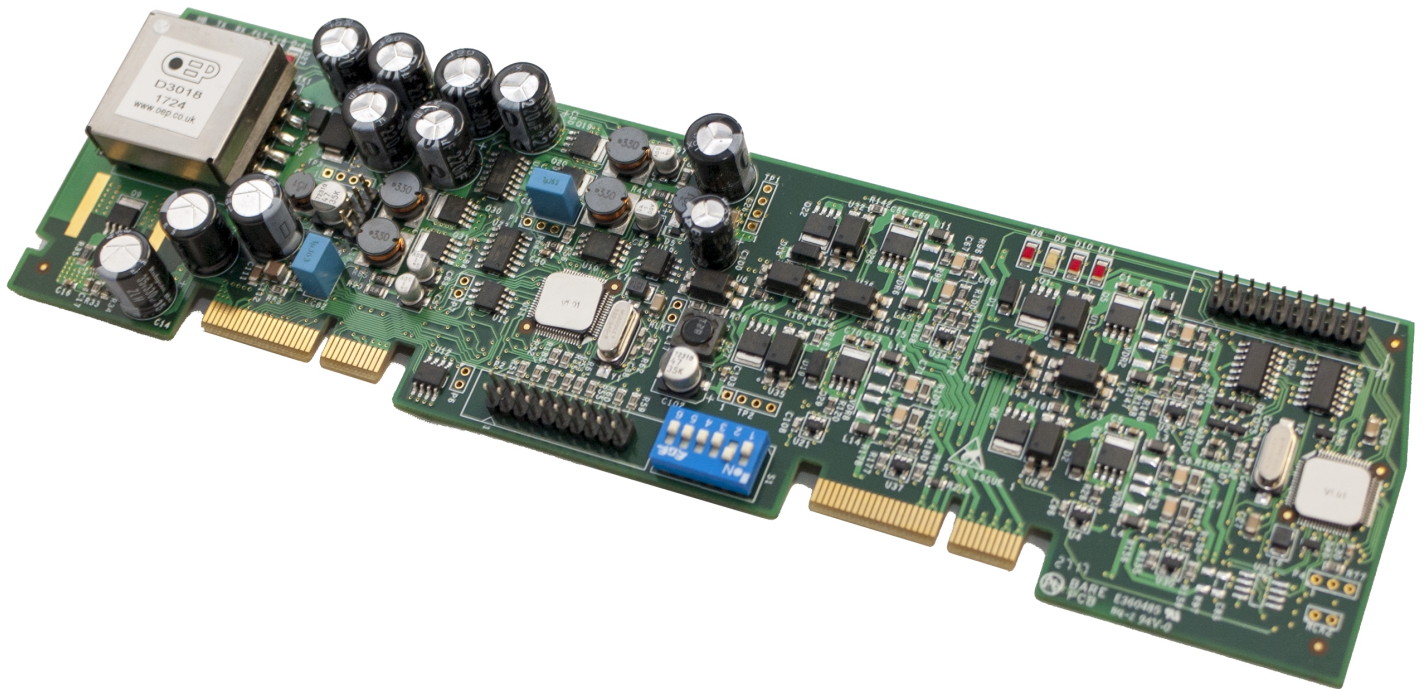

Dual Loop Panel Module

S758

The Dual Loop Panel Module monitors loop device status and provides status to the panel processor. It holds device configurations and operates in a standalone manner when catastrophic failures occur. The Dual Loop Panel Modules can be connected in any available slot (C-K) on the Main Back Board to provide this operating function.

Each Dual Loop Panel Module can support either Hochiki or Apollo protocols.

INSTALLATION

This section provides instructions for connecting cables, mounting, and testing the Dual Loop Panel Module Panel Module for installation.

| | |
|--------------------------|---|
| <input type="checkbox"/> | Notify the monitoring center and location security that the Taktis Fire Alarm Control Panel will be temporarily out of service. |
| <input type="checkbox"/> | Remove the module from its packaging and check its contents. |
| <input type="checkbox"/> | Set the address of the module(s), as shown in Setting the Address . |
| <input type="checkbox"/> | Connect field wiring. Refer to Wiring below for details. |
| <input type="checkbox"/> | Remove AC and battery power from the panel. |
| <input type="checkbox"/> | Install the module(s) into an open slot on the Main Back Board and/or Extension Board. |
| <input type="checkbox"/> | Restore AC and battery power. |
| <input type="checkbox"/> | Wait for the panel start-up process to complete. Refer to the Taktis Fire Alarm Control Panel Installation Manual (MAN-1431KE) for more information. |
| <input type="checkbox"/> | Test communication from the panel via the LED Status Indicators . |

Install this product in accordance with NFPA 72, the National Electrical Code, and all local codes.

WARNING! The module must be installed by personnel familiar with electronic components. Electronic components within the module are vulnerable to damage from electrostatic discharge. Ground straps must be worn by installers before handling to prevent electrostatic discharge damage.

Before You Begin

The following item is not included with the Taktis Fire Alarm Control Panel, but is required for the installation:

- A Ground Strap is required for handling circuit boards.

Setting the Address

There can be up to 4 Dual Loop Panel Modules connected to a Taktis Fire Alarm Control Panel. Configure an address on the Dual Loop Panel Module by selecting a binary number on the SW1 DIP switch. Address 32 must be set to off on all DIP switches.

Each panel module of the Taktis Fire Alarm Control Panel must contain a unique setting before being connected to the Main Back Board. The binary setting of the DIP switch sets the specific address for the panel module. The numeric order of the address setting between modules does not impact operation, but each panel module must be assigned a separate / unique address.

The black portion of the DIP switch identifies the switch actuator.

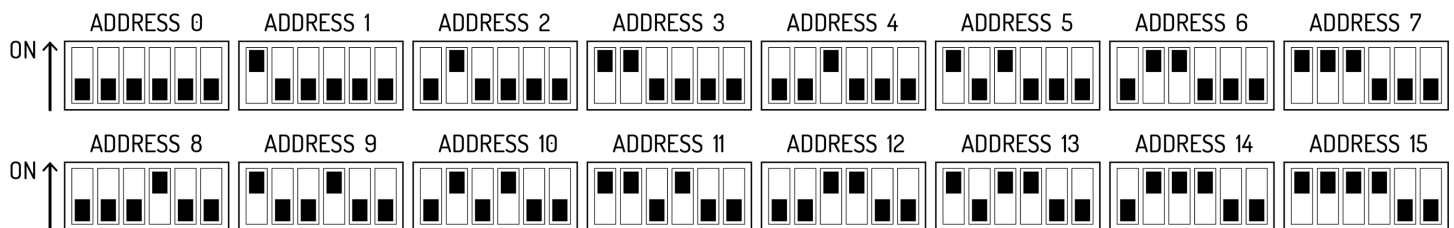

Address 0 is shown above for illustrative purposes only. Address 0 should never be used.

For addresses above 15, switches 5 and 6 will need to be used.

- For address 16-31, switch 5 should be in the ON position. Switch 5 ALONE adds 16 to the address number. For example, for address 20, set the switch position to address 4 shown above and switch 5 in the ON position.
- For address 32-47, switch 6 should be in the ON position. Switch 6 ALONE adds 32 to the address number.
- For address 48-63, switches 5 AND 6 should be in the ON position. Switches 5 and 6 TOGETHER adds 48 to the address number.

Placement

To install modules on the Taktis Fire Alarm Control Panel:

1. Disconnect AC power and standby batteries prior to performing the module installation.
2. Remove the retaining screw and plastic cover.



3. Remove the panel module from the protective packaging using adequate electrostatic protection.
4. Point the conductor side of the panel module toward the backplate.
5. Insert the notched end of the panel module in the metal guide notch of the backplate at an angle, as shown.

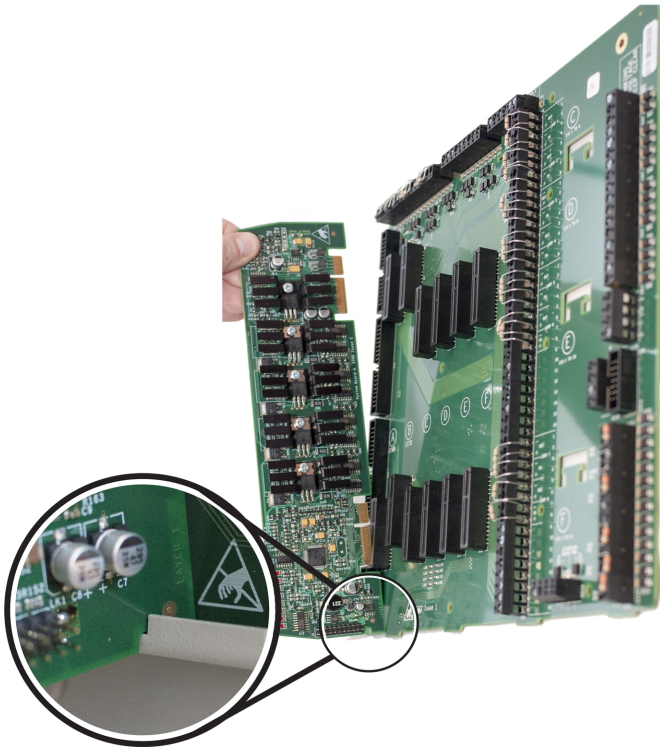

The photo above is an example of panel module placement and may not be representative of the specific module and slot placement described in this guide. Refer to the checklist above for details on placement.

6. Rotate the panel module until all conductors are securely inserted into connectors of the Main Back Board.
7. Replace the cover onto the Main Back Board.
8. Reconnect the batteries and restore AC power.

Wiring

No SLC Devices

When the loop is unused, the loop termination jumpers provided with the panel should be replaced with 14-22 AWG SLC cable.

The Taktis Fire Alarm Control Panel provides a trouble signal when unused loops are not terminated. All loops are supervised.

**DUAL LOOP MODULE WIRING
WITH NO DEVICES CONNECTED**

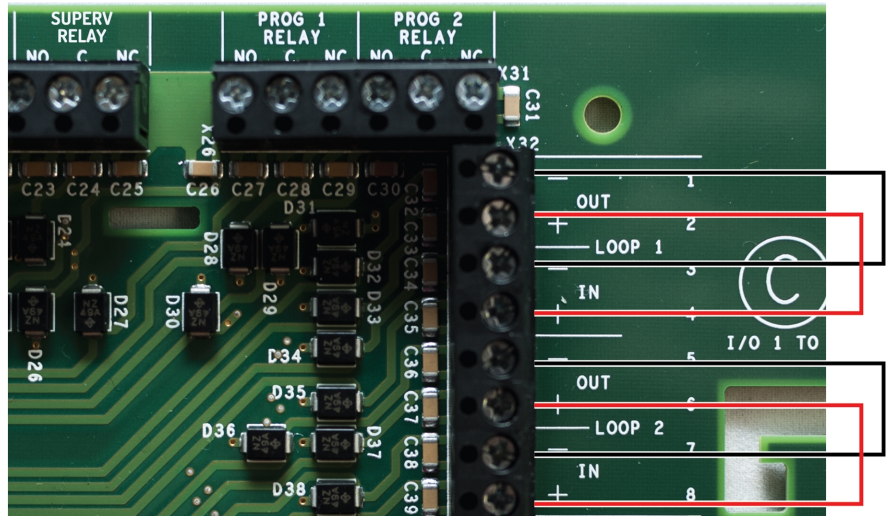

Class A SLC Loops

1. Connect Class A loops to the terminal strip of the Taktis Fire Alarm Control Panel.
2. When the loop is unused, the loop termination jumpers provided with the panel should be replaced with 14-22 AWG SLC cable.

The Taktis Fire Alarm Control Panel provides a trouble signal when unused loops are not terminated. All loops are supervised.

Follow NFPA guidelines for placement of isolators with Class A wiring.

CLASS A LOOP CONNECTION CONTAINING SIX ADDRESSABLE SENSORS

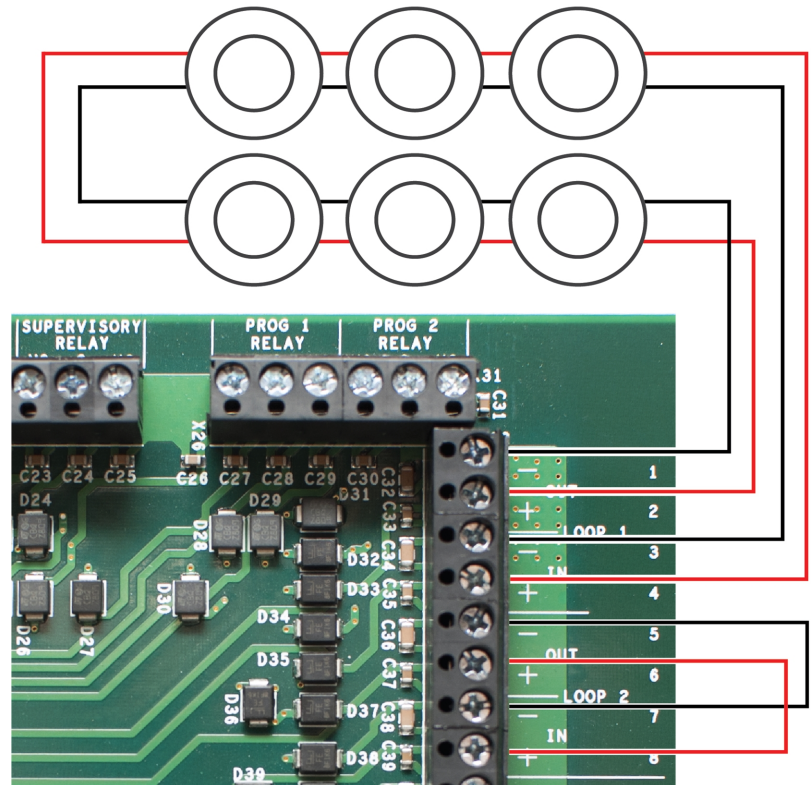

Class B SLC Loops

Class B loops may not be permitted in all regions. Check local codes of practice before using Class B SLC circuit configurations.

1. Connect Class B loops to both the IN and OUT terminals of the terminal strip. Do not insert more than one conductor per terminal. Use wire nuts or other suitable splice connectors to connect the Class B loop cable to both the IN and OUT terminals.
2. When the loop is unused, the loop termination jumpers provided with the panel should be replaced with 14-22 AWG SLC cable.

SLC cabling must be sized according to length and device load to ensure that the voltage-drop of the cable does not result in an inadequate operating voltage on the circuit.

Refer to the Taktis Fire Alarm Control Panel Installation Manual (MAN-1431KE) for an example of how isolators may be used on a Class B circuit.

CLASS B LOOP CONNECTION
CONTAINING THREE ADDRESSABLE SENSORS

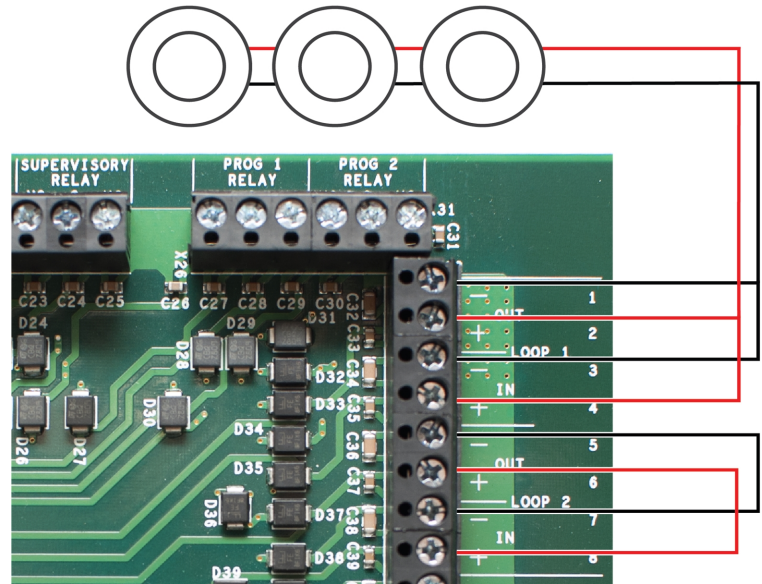

Class X SLC Loops

1. Connect Class X loops to the terminal strip of the Taktis Fire Alarm Control Panel.
2. When the loop is unused, the loop termination jumpers provided with the panel should be replaced with 14-22 AWG SLC cable.

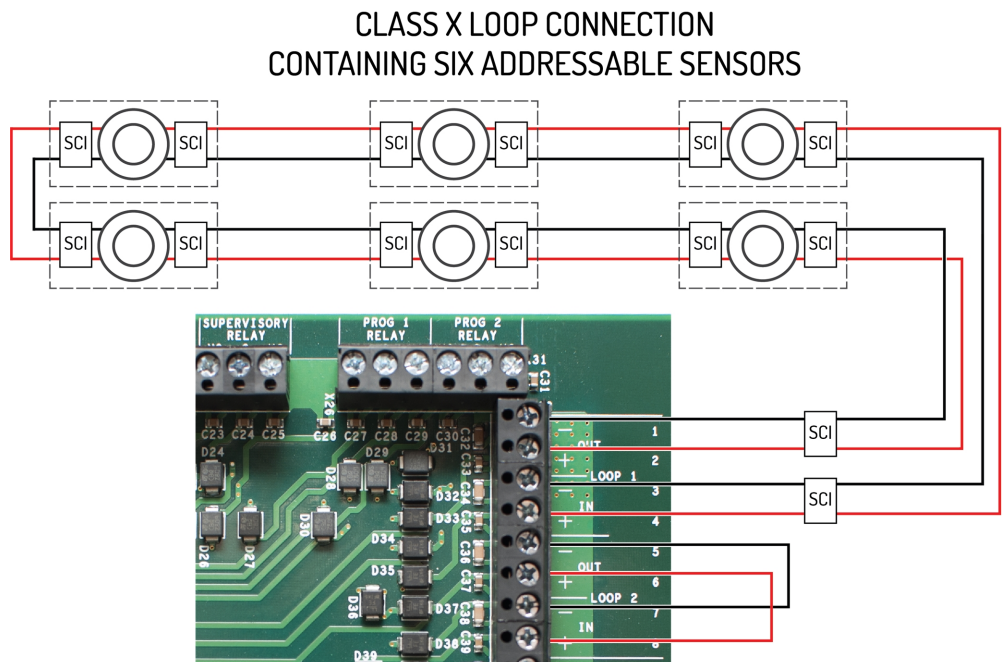

The Taktis Fire Alarm Control Panel provides a trouble signal when unused loops are not terminated. All loops are supervised. Follow NFPA guidelines for placement of isolators with Class X wiring.

When using Class X wiring, SCI Short Circuit Isolators must be installed before and after each analog addressable device on the SLC loop. Alternatively, analog devices with built-in SCI may be used.

The wiring from the control panel to the first SCI and from the last SCI back to the control panel must be in conduit.

Testing

LED indicators provide diagnostic information to identify communication.

| LED Label | Name | Color | Description |
|-----------|---------------|--------|--|
| LED D8 | Heartbeat | Red | Heartbeat for Processor 2 |
| LED D9 | Trouble | Yellow | Trouble status for Processor 2 |
| LED D10 | Loop 1 | Red | Identifies whether Loop 1 is on or off. |
| LED D11 | Loop 2 | Red | Identifies whether Loop 2 is on or off. |
| HB | Heartbeat | Red | Identifies functional status of Dual Loop Panel Module. |
| TX | Tx Comms | Green | Identifies transmitting data. |
| RX | Rx Comms | Green | Identifies receiving data. |
| FLT | Trouble | Yellow | Identifies an error condition. |
| I-A | Input Active | Red | Indicates that the input is actively receiving data. |
| O-A | Output Active | Red | Indicates that the output is actively transmitting data. |

SPECIFICATIONS

This appendix provides electrical and environmental specifications for the Dual Loop Panel Module.

| | |
|------------------------------------|-------------------------------|
| Supply Voltage | 24 V DC |
| Loop Voltage Range | 25 - 38 V DC |
| Maximum Loop Current | 400 mA |
| Maximum Current Consumption | 1.5 A |
| Protocol(s) Supported | Hochiki |
| Temperature Range | -5°C - 49°C or 23°F - 120°F |
| Relative Humidity | Up to 95%, non-condensing |
| Dimensions | 234.6mm x 62.8mm or 9¼" x 2½" |

INDEX

C

Cabling 15

Class A 4, 14

Class B 15

Class X 16

D

DIP Switch 10

Dual Loop 7-8, 18

H

Heartbeat 17

M

Main Back Board 7-8

S

SLC 13

Standby Batteries 11

T

Terminals 15

Trouble 13

GLOSSARY

A

AHJ

Authority Having Jurisdiction. The government body, organization, office, or individual having the power to enforce and/or interpret laws, codes, and rules.

Ancillary Device

A device connected to a fire alarm system not required by the fire alarm standard, but may be required by other standards, e.g. door holders, smoke control fans, remote LED indicators, remote alarm, or trouble units.

AWG

American Wire Gauge. The standard American designation of wire sizes. Wire size is an inverse relation to gauge numbers that range from 0000 to 40 AWG. Also called Brown and Sharpe or B&S gauge.

C

Class A

A wiring classification of circuits capable of transmitting an alarm signal during a single open or non-simultaneous ground fault on a conductor.

Class B

A wiring classification of circuits NOT capable of transmitting an alarm signal beyond a single open or during a short between conductors.

Class X

A wiring classification capable of transmitting an alarm signal during a single open, short, or non-simultaneous ground fault on a conductor.

D

DIP Switch

A group of two-position electrical contacts mounted in a Dual Inline Package (DIP), typically used to set address or function information.

E

End-Of-Line Device (EOL)

An electronic component physically installed as the furthest device from the control panel; whose presence on the circuit is used to monitor the integrity of the circuit.

L

Loop Explorer 2

Windows-based configuration software for the Fire Alarm Control Panel

N

NAC

Notification Appliance Circuit. A supervised output circuit that connects horns, strobes, speakers, etc. to the control panel.

S

SLC

Signaling Line Circuit. A Signaling Line Circuit (SLC) carries data to and from the field devices for the fire alarm system, and also carries power from the control panel to the devices.

Supervision

Monitoring the integrity of a circuit or device to detect a fault condition that would prevent normal operation.