

Features

- Built-in 100v/70v transformer
- Wall mount type loudspeaker
- 5" +1.5" two ways speaker unit
- RMS 50W @100V
- Metal grille, ABS enclosure and stainless mounting bracket

Description

The T-775SW is a wall mount speaker built-in 70v/100v transformer. The 70v/100v transformer technique reduces line losses on longer distance and allows easy parallel connection of multiple loudspeakers.

The built-in 5"+1.5" two ways speaker driver is designed of wide frequency response 80-20KHz, the RMS 50W power outputs are suitable for most of the applications.

The ABS grille, ABS enclosure and stainless mounting bracket are of black color. Easy and secure wall mount installation through the supplied mounting bracket.

It is ideal choice for industrial and commercial applications in hotel, school, office and factory where background music and paging is needed.



Specification

Model	T-775SW
Rated power(100V)	50W
Maximum power	100W
Sensitivity	90dB
Impedance	200Ω
Frequency response	80-20KHz
Material	plastic
Speaker unit	5" x 1 1.5" x 1
Size	285 x 180 x 186mm
Weight	3.0Kg

Appearance:

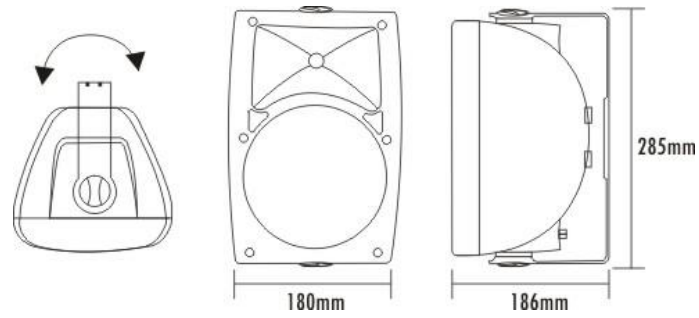

Direction Diagram:

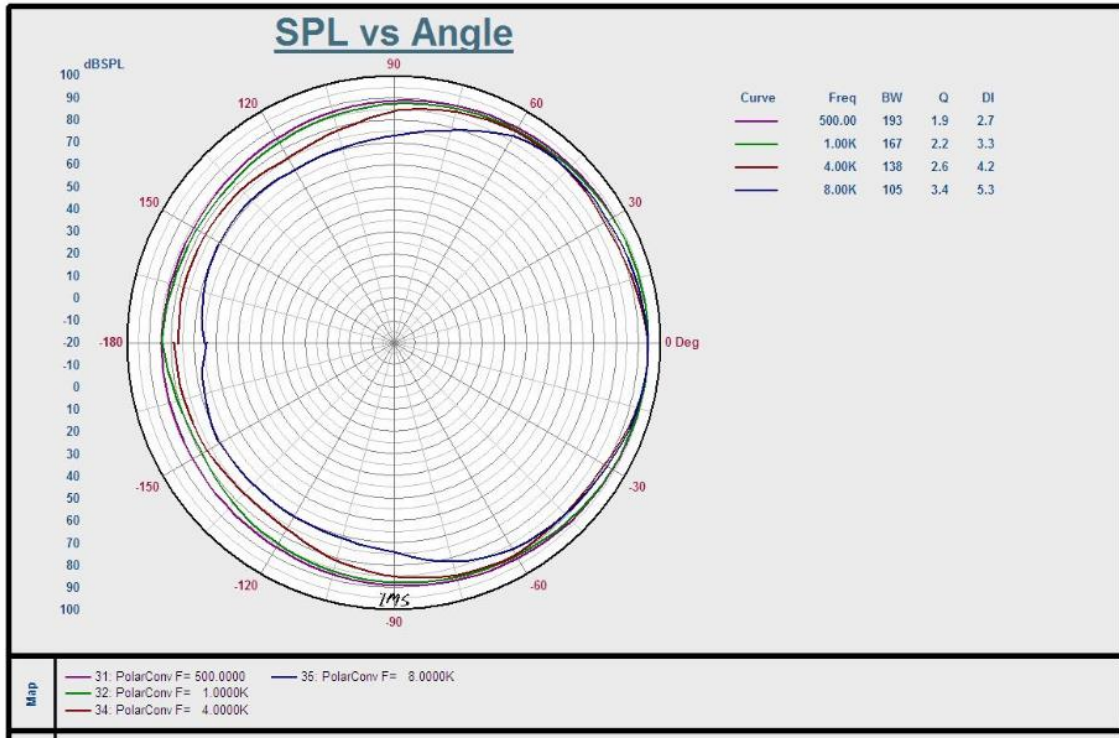

Frequency Response:

